

Specifications

Parameter	Unit	Minimum	Typical	Maximum
Center Frequency	MHz	165.4	165.5	165.6
Insertion Loss	dB	-	27.2	28.5
1 dB Bandwidth	MHz	7	7.02	-
3 dB Bandwidth	MHz	-	7.25	-
30 dB Bandwidth	MHz	-	7.94	8.05
40 dB Bandwidth	MHz	-	8.03	8.4
50 dB Bandwidth	MHz	-	8.11	9
Passband Variation	dB	-	0.7	1
Absolute Delay	usec	-	3.7	-
Group Delay Variation($f_0 \pm 3.5\text{MHz}$)	nsec	-	130	300
Ultimate Rejection	dB	50	55	-
Material Temperature coefficient	KHz/°C	-2.979		
Ambient Temperature	°C	25		
Package Size	DIP2712 (27.0x12.8x4.7mm3)			

Notes:

1. All specifications are based on the test circuit shown
2. In production, devices will be tested at room temperature to a guardbanded specification to ensure electrical compliance over temperature
3. Electrical margin has been built into the design to account for the variations due to temperature drift and manufacturing tolerances
4. This is the optimum impedance in order to achieve the performance show

Matching Configuration

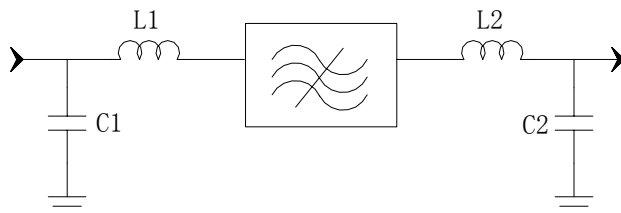

L1=18nH L2=15nH
C1=C2=56pF
Source/Load Impedance=50 ohm

Notes - Component values may change depending on board layout.



SIPAT Co., Ltd.
(CETC No. 26 Research Institute)
Nanping Huayuan Road No. 14
Chongqing, China, 400060

Part Number	LBT16502		
Rev. Date	2006-1-11		
Rev.	1.0	Page 1/3	

Package Dimension

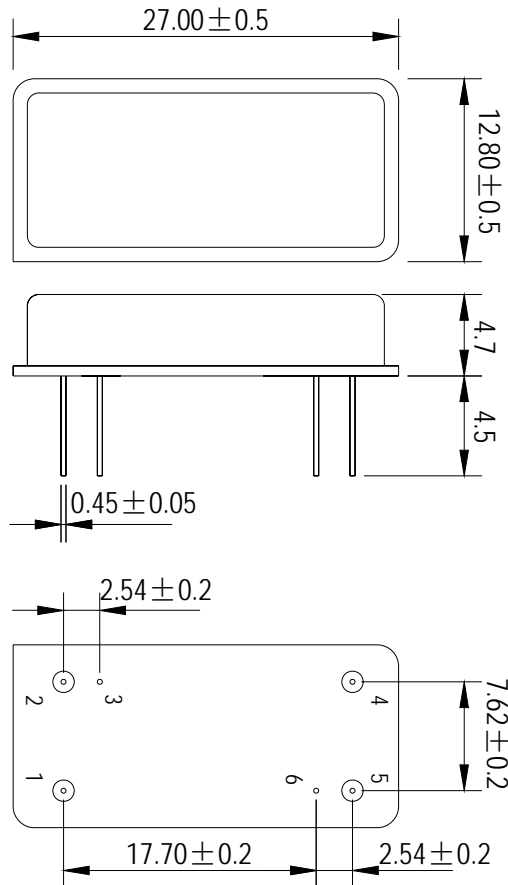

Input:1
Output:5



SIPAT Co., Ltd.
(CETC No. 26 Research Institute)
Nanping Huayuan Road No. 14
Chongqing, China, 400060

Part Number	LBT16502	
Rev. Date	2006-1-11	
Rev.	1.0	Page 2/3

Typical Performance

Frequency Respond

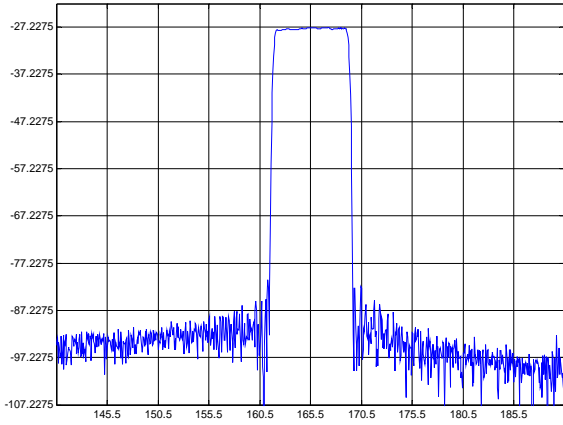

Passband Respond

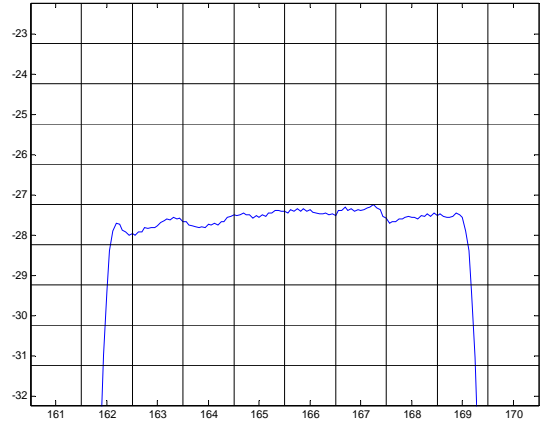

Group Delay Variation($f_0 \pm 3.5\text{MHz}$)

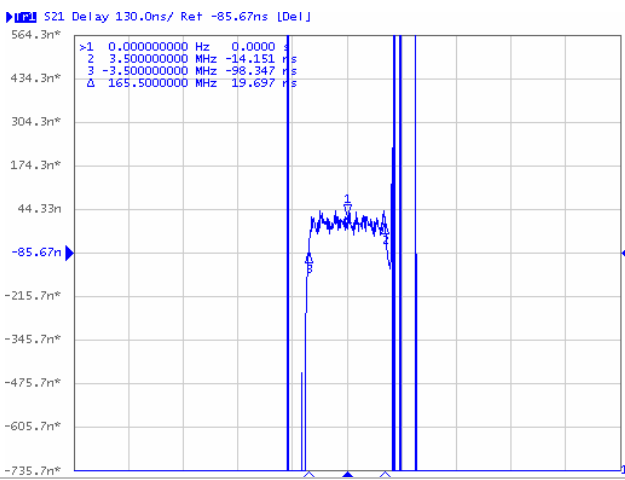

Phase Linearity($f_0 \pm 3.5\text{MHz}$)

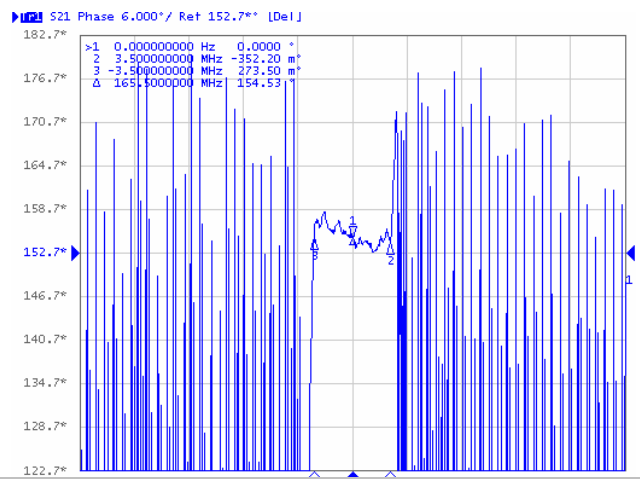

Smith Chart S11

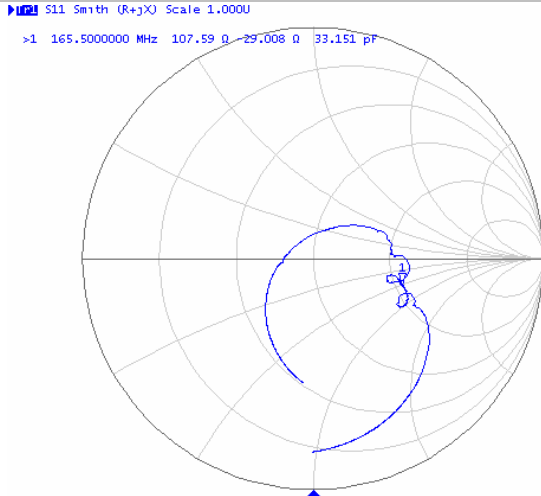

Smith Chart S22

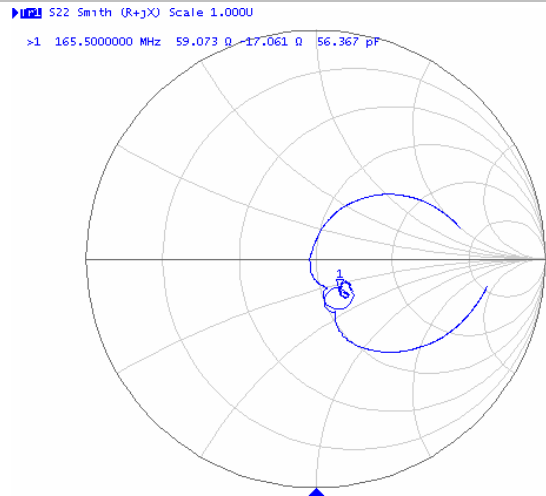

SIPAT Co., Ltd.
(CETC No. 26 Research Institute)
Nanping Huayuan Road No. 14
Chongqing, China, 400060

Part Number	LBT16502	
Rev. Date	2006-1-11	
Rev.	1.0	Page 3/3